

**Centre for Archaeological Fieldwork,
School of Geography, Archaeology and Palaeoecology,
Queen's University Belfast**



**Archaeological Excavations at Squire's Hill,
Belfast, Co. Antrim**

Data Structure Report No. 118

Licence number AE/16/65

On behalf of





Archaeological excavations at Squire's Hill, Belfast, Co. Antrim

Ruairí Ó Baoill

CAF DSR No. 118

Licence number: AE/16/65

NISMR: ANT 056:039

Grid reference: J30330 78190

May 2016

On behalf of



Contents

1	Introduction	3
2.	Archaeological background to the site	3
3	The Excavation programme	6
	Trench 1	7
	Trench 2	8
4	Discussion	13
5	Acknowledgements	15
6	References	15
	Appendix 1: Lithics Report by Brian Sloan	16
	Appendix 2: Context Register	20
	Appendix 3: Harris Matrix	22
	Appendix 4: Drawing Register	23
	Appendix 5: Photographic Register	24
	Appendix 6: Finds Register	26

1. Introduction

In April 2016 the Centre for Archaeological Fieldwork (CAF) in the School of Geography, Archaeology and Palaeoecology at Queen's University Belfast was commissioned by Cultúrlann McAdam Ó Fiach and the Spectrum Centre to devise and lead a two-week community-based archaeological fieldwork programme on their behalf as part of the Farset Heritage Project, funded by the Heritage Lottery Fund. The site selected for the investigation was on the south-facing slope of Squire's Hill on the outskirts of Belfast (grid reference: J30330 78190), with the fieldwork being conducted between 18th April and 29th April 2016. Located in the townland of Ballysillan Upper and in the parish of Shankill, the excavation at Squire's Hill was directed by Ruairí Ó Baoill and was of a reconnaissance nature, undertaken close to where a range of prehistoric artefacts had previously been discovered in 1938 (Evans 1938) with the objective of investigating if this had once been the location of a settlement. The new programme of work subsequently revealed flint artefacts diagnostic of an early Neolithic date (c.4000 BC to c.3500 BC) along with a number of subsoil-cut features that may have been foundations trenches for ancient structures. As such, it would seem that the site had been used by our "first farmer" ancestors, at a time when cereals, domesticated animals, pottery, and burial monuments had been introduced into Ireland. The investigation also discovered a simple blue bead from the Early Medieval period, and a selection of artefacts of Early Modern date, including sherds of ceramic vessels, glass, slate, clay tobacco pipes, an iron nail and a bottle stopper.

The excavation was led by professional archaeologists, but this was a community-based programme that enabled members of the local community to participate in the fieldwork, and approximately 300 school children and adult volunteers participated in the excavation or visited the site during the course of the work, while there was an Open Day (Saturday 23rd April) when tours took place and artefacts uncovered during the excavation were on display for the public to see.

2. Archaeological background to the site (Fig. 1; Plate 1; Table 1)

Located along the 900ft/275m contour line, the site of the excavation was a green field of rough pastureland on the south-facing slope of Squire's Hill, with impressive views to the south over Belfast (Fig 1; Plates 1 to 4). During prehistoric times there was extensive settlement in the Belfast Hills (Ó Baoill 2011, 11-49) and the 1938 excavation had revealed flint artefacts "together with fragments of blue-stone [porcellanite] axes, worked blades...and a few plain burnished pots" (Evans 1938, 322). This discovery was judged to date to the

Neolithic period and the site was subsequently included in the Northern Ireland Sites and Monuments Record (NISMR) as ANT 056:039.

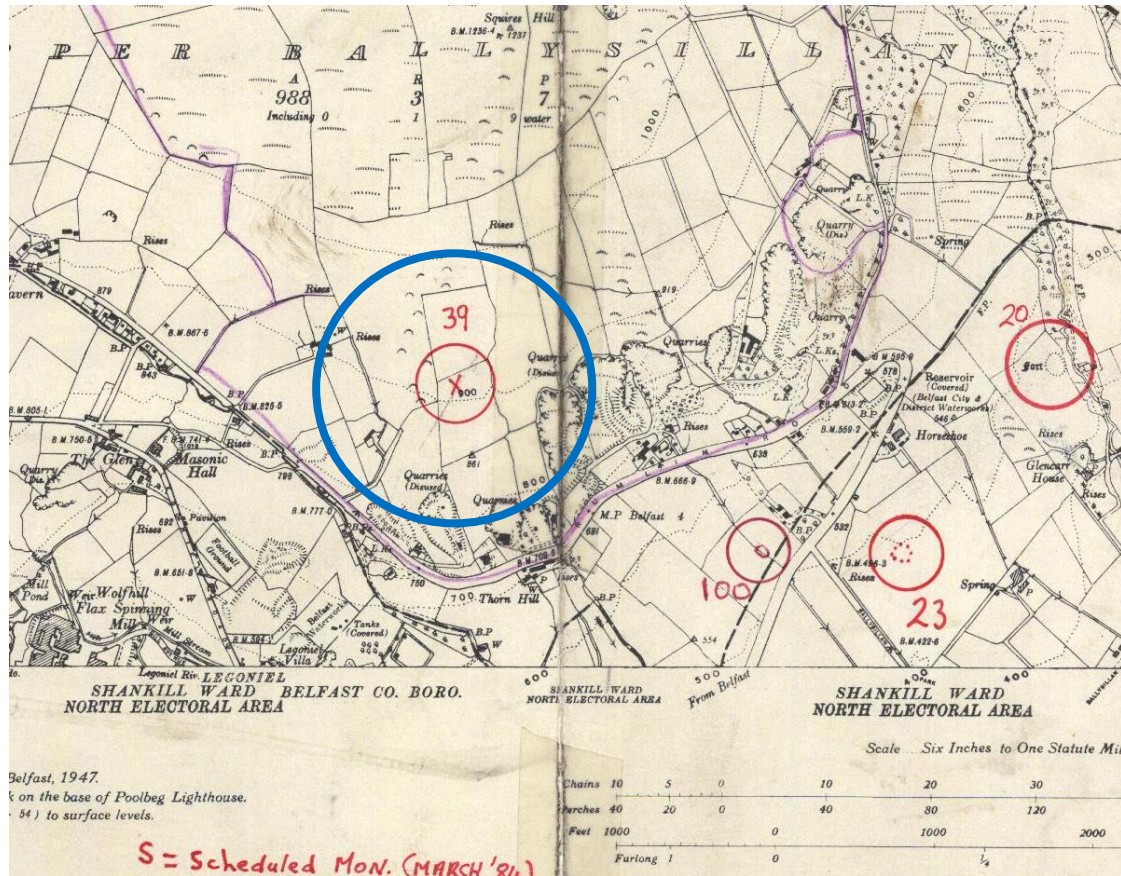

Fig 1. The location of the 1938 find-spot, as marked on the 1947 OS map of Belfast held in the NISMR. The site is identified as ANT 056:039 and marked with an 'X'. The 2016 excavation trenches were located either side of this 'X', based on the grid reference coordinates provided within the NISMR.



Plate 1. Aerial photograph of the 1938 find-spot from the NISMR. To the left of the photograph, the site marked as "6" is ANT 056:039.

There are a number of other archaeological sites in the environs of the site excavated in 2016 on Squire's Hill and these are recorded in the Northern Ireland Sites and Monuments Record (NISMR).

NISMR Number	Site type
ANT 056:023	Enclosure
ANT 056:020	Sub-rectangular enclosure
ANT 056:021	Enclosure
ANT 056:022	Enclosure
ANT 056:038	Rath and souterrain
ANT 060:023	Enclosure
ANT 060:057	Aerial Photo site - elliptical cropmark
ANT 060:067	Enclosure
ANT 056:054	Rath and souterrain

Table 1. Known archaeological sites in the environs of the 1938 Neolithic find-spot on the southern slope of Squire's Hill, Belfast.



Plate 2. Squire's Hill, Belfast. The location of the two trenches (Trench 1 and Trench 2) excavated in April 2016. The circle between the trenches marks the grid reference coordinates for the location of the 1938 find-spot, as provided within the NISMR.

3. The Excavation Programme

The excavation took place from 18th April to 29th April 2016 and was led by a five-person crew from CAF under the direction of Ruairí Ó Baoill. Two 5m x 2m trenches (Trench 1 and Trench 2) were opened to either side of the 1938 Neolithic find spot (Plate 2 and 3), based on the coordinates provided within the NISMR. These trenches were excavated by trowel, with all features recorded using context sheets, section drawings, plans and photographs, thereby generating an archive for the investigation. Separate context registers were maintained for each trench with a separate set of context numbers related to each unit (Trench 1 = Context 100 onwards; Trench 2 = Context 200 onwards).

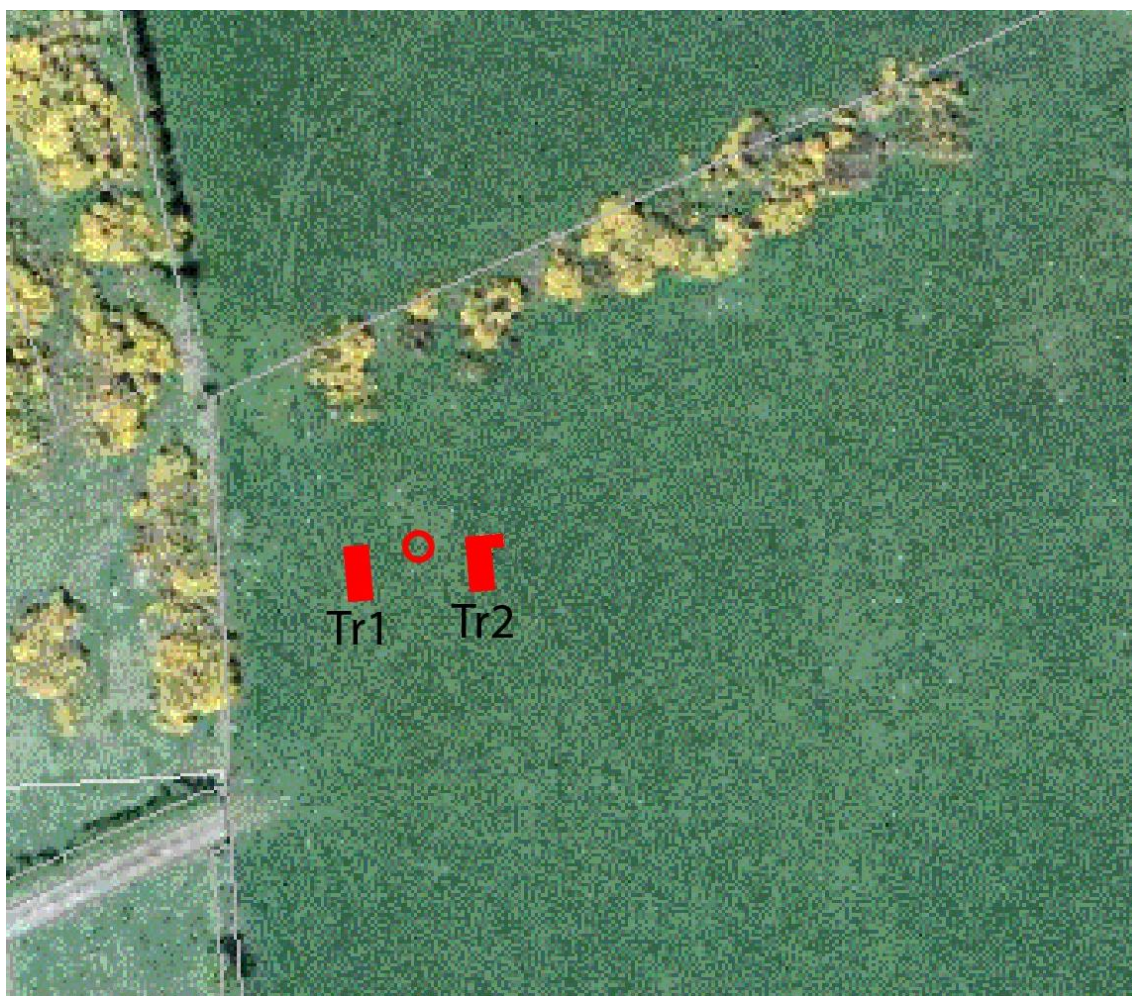

Plate 3. Squire's Hill, Belfast. Detailed photograph of the location of the two trenches excavated in April 2016. The circle between the trenches marks the grid reference coordinates for the location of the 1938 find-spot, as provided within the NISMR.

Trench 1 (Plates 4 and 5)

Trench 1 was located close to but west of the approximate site of the 1938 find-spot. The trench measured 5m long (from north to south), by 2m wide (from east to west) and it sloped down to the south in line with the topography of the field. There was a maximum of 0.20m depth of strata within the trench and no archaeological features were uncovered during the excavation. Immediately below the sod layer (C.101) was topsoil (C.102) which was a mid-brown clay soil containing gravel and small stone inclusions. Finds recovered from it included prehistoric flint, possible metal slag, and a range of Early Modern artefacts including ceramic sherds, glass, window lead flashing, a ceramic bottle stopper and a clay pipe bowl. The topsoil lay immediately over subsoil (C.103) which was a firm orange-brown sandy clay, containing small patches of stone inclusions and with underlying bedrock protruding throughout the trench.



Plate 4. Squire's Hill, Belfast. Community volunteers help out with the excavation of Trench 1 under the supervision of the CAF's Grace McAlister. Photo taken from the west.



Plate 5. Squire's Hill, Belfast. Trench 1 fully excavated to subsoil clay and bedrock. Photo taken from the south.

Trench 2 (Plates 6; Figs 2 to 5)

Trench 2 was located close to but east of the approximate site of the 1938 find spot. As with Trench 1, Trench 2 initially measured 5m long (north to south) by 2m wide (from east to west) and it sloped down to the south in line with the topography of the field. A small 1m square extension was later excavated at the north-eastern corner of the trench. There was a maximum of 0.52m of stratigraphy in the trench. Immediately below the sod layer (C.201) was topsoil (C.202), a brown sandy clay loam containing small angular stones and a range of Early Modern artefacts including pottery, slate, glass and a clay tobacco pipe. The topsoil was also found to contain a small simple blue bead of Early Medieval date (Special Find No. 17). With its perforation slightly off-centre, the bead would have formed part of a necklace or bracelet, and it acts as a reminder that human activity in the area was not restricted to prehistoric times but continued on through to the Early Medieval period as well.

Below the topsoil horizon there were five substantial subsoil-cut features within the area under investigation: C.205, C.207, C.209, C.211 and C.213. At the southern end of the trench was a linear cut (C.207), aligned from north-west to south-east, which ran from beyond the southern limit of the trench into and beyond the western section face. The 2m long stretch of this feature recorded within the confines of the trench varied in width (between 0.25 to 0.30m) and depth (between 0.50-0.90m) and had gently sloping sides and a flattish but uneven base.

The feature was filled with orange-brown sandy clay (C.206) containing some angular stones while 34 flint pieces were also retrieved within this matrix. Although of uneven nature, it is possible that the cut was associated with a larger structure that extended outside the area under investigation and, given the artefacts discovered within the excavated section, this structure may have been of prehistoric date.

At the northern end of the trench a second major feature was uncovered. This was a curving linear cut (C.211) that was recorded for a distance of 2.50m. The feature ran approximately from north-east to south-west for 1.70m and at both its western end and eastern end it turned 90° towards the south for 0.80m and 0.40m respectively; there was a distance of 1.20m between the sides of these two turns. The feature varied in width from 0.30m to 0.54m and in depth from 0.10m to 0.25m and had gently sloping sides and a flattish base except where it turned southwards at its western end; here the eastern edge of the cut was vertical and the western side was gently sloping. C.211 was filled with a brown sandy loam (C.210) containing 209 flint artefacts, small angular and sub-rounded stones, and occasional charcoal flecking.

Contemporary with this curving linear cut (C.211) was another smaller feature (C.213), located in the north of the trench and measuring 0.70m in length (from east to west) by 0.50m in width (from north to south) and 0.35m in depth. The feature may represent a posthole since it had a mixture of steep and gently sloping sides and a slightly concave base and it is possible that it was contemporary in date with the linear cut (C.211), while its fill (C.212) was very similar in nature to that encountered within the linear cut (C.210) and contained 27 flint pieces. As such, it can be suggested that both features were part of the same structure, with the linear cut (C.211) representing evidence for wallslots and the possible posthole (C.213) housing a timber upright.

A distance of 0.40m north of curving linear feature (C.211) was a second cut feature which can be interpreted as a pit or a posthole (C.209). This feature was only partially excavated as it extended beyond the northern limits of excavation trench but it had maximum recorded dimensions of 0.55m in length (from east to west) by 0.20m in width (from north to south) and 0.25m in depth. With steep vertical sides and concave base, the feature was filled with a dark brown sandy loam (C.208) that contained occasional charcoal flecking, small angular stones and 13 pieces of flint.

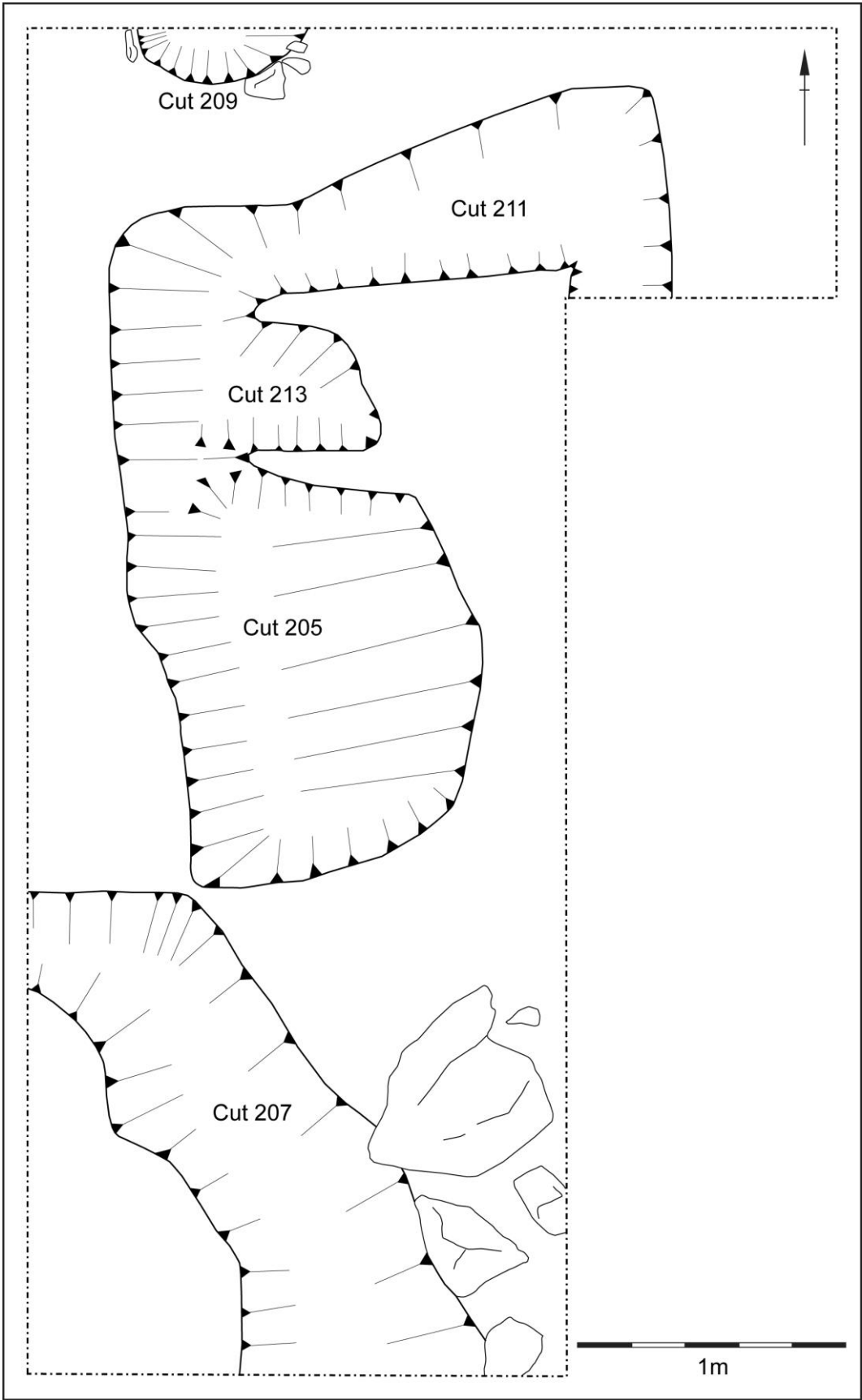

Fig 2. Squire's Hill, Belfast. Trench 2, depicting features cut into the subsoil.



Plate 6. Squire's Hill, Belfast. Trench 2, showing the main features cut into the subsoil, but before the small extension to the trench was added at its north-eastern corner. Photo taken from the north and showing subsoil features C.211, C.213, C.205 and C.207.

The only other feature uncovered in Trench 2 was a large rectangular cut (C.205) located in the middle of the trench. This feature was 1.5m in length (from north to south) by 1.20m in width (from east to west) and 0.40m in depth. The western edge of the cut was fairly steep but it was gentler on the eastern side. Filled with a brown clay loam (C.204) and containing medium-sized angular stones (0.05 to 0.15m in length) in its base, the matrix also contained 131 pieces of struck flint but also – significantly – an iron nail. Given the discovery of the latter artefact it can be suggested that this feature was a modern machine-dug hole (perhaps excavated to examine the depth or nature of soil in the field and then backfilled) but its excavation cut through the south-western end of the earlier prehistoric linear feature (C.211) and its associated posthole (C.213).

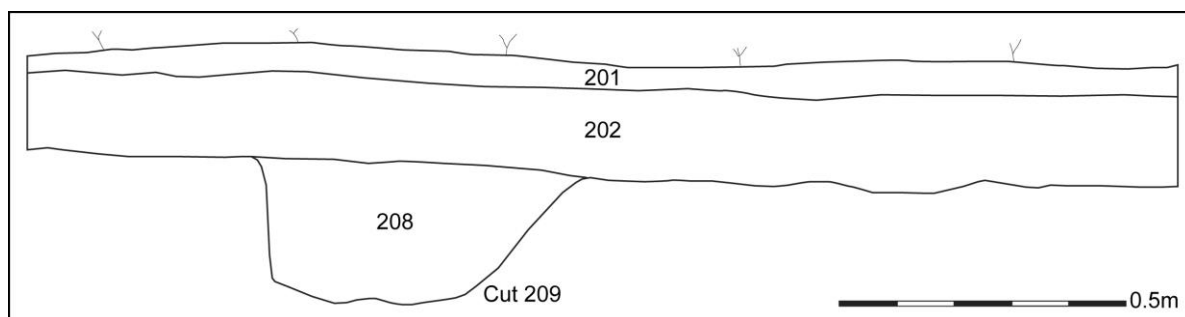

Fig 3. Squire's Hill, Belfast. Trench 2. South-facing section.

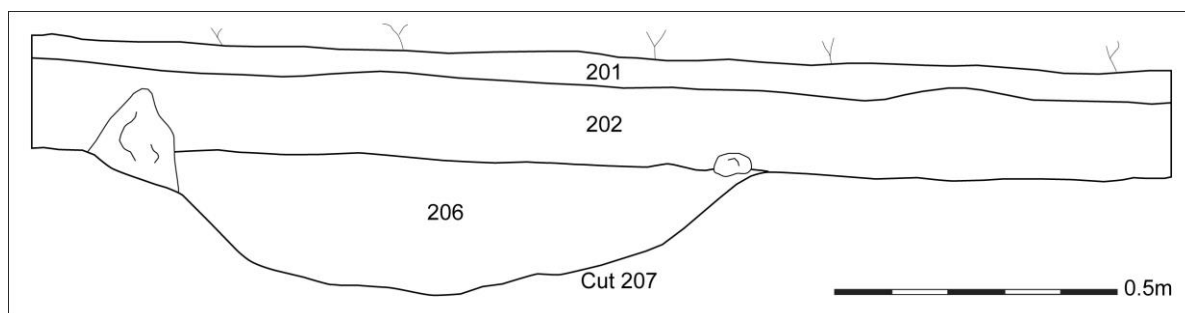

Fig 4. Squire's Hill, Belfast. Trench 2. North-facing section.

4. Discussion

A wide variety of Early Modern ceramic types were uncovered in the topsoil level during the course of the excavation, including sherds of Brown Glazed Earthenware, Black Glazed Earthenware, Transfer Printed Earthenware, Creamware, Staffordshire Ware and Stoneware; to this corpus we can add two clay tobacco pipe bowls and some pieces of roofing slate. While these artefacts do indicate human activity on the hillside during recent centuries, they should not be taken as evidence of settlement activity on Squire's Hill and we would envisage that they were deposited here as a result of "night soil" manure being spread on the fields in Victorian times. The vast majority of the artefacts encountered during the excavation, however, were of prehistoric date.

The investigation at Squire's Hill was of a fortnight's duration and, as such, the work was of a reconnaissance nature, designed to elucidate further detail on the find-spot reported in the pages of the *Proceedings of the Prehistoric Society* as a one-page note compiled by Estyn Evans in 1938. The two excavated trenches were positioned to either side of the grid reference coordinates for the 1938 find-spot, as recorded in the Northern Ireland Sites and Monuments Record (NISMR), but – unfortunately – no evidence of the 1930's excavation was uncovered in either. On a more positive note, the modern investigation – like its predecessor – demonstrated that there was a very high struck flint content in the soil excavated in both trenches and this would indicate that there must have been prehistoric activity in this area. More than 2,000 pieces of flint were recovered from the excavation, mostly from the topsoil horizons (See Appendix 1) and, although relatively undiagnostic as a whole, certain elements within the assemblage - in particular the simple hollow scrapers (see Appendix 6: Special Finds No.10 and No.11) – suggests an early Neolithic date (c. 4000 BC to c. 3500 BC). It is apparent, however, that the general lack of formalised tools and the minimal nature of any retouch suggests that the flint-knapping episodes were carried out in a rather ad hoc fashion producing basic tools as and when required. Added to this is the fact that no sherds of Neolithic pottery or porcellanite axes were discovered (although Evans did include both as being among the artefacts retrieved in 1938) which might suggest that this area was used for industrial, and not domestic, purposes.

While no archaeological features were uncovered in Trench 1, the evidence from Trench 2 suggests prehistoric structural activity at this location, with a number of subsoil-cut features encountered. How many of these features were contemporary must remain uncertain, but the curving linear feature (C.211) and the associated posthole (C.213) in the north of the trench may represent a section of a prehistoric structure, perhaps the corner of a wall slot

and a posthole to carry a loadbearing timber. The exact function and date of the pit or posthole (C.209) immediately to the north of these features remains unknown but it may also have been connected to this possible structure. A degree of care, however, needs to be exercised at this point since the space between the two sides of C.211 is only 1.20m in width; as a consequence, it would be difficult to identify this feature as representing the wall-slots for a domestic building given that it would have been of a very restricted internal area. Perhaps, however, this was part of a prehistoric industrial structure – perhaps a storage area or a wind-break – used by the people working the flint resource at this location; the close proximity of the source of the River Farset would certainly have made Squire's Hill an attractive site for prehistoric people to base themselves while exploiting the flint outcrops that are found here and also at nearby Wolf Hill. It should also be noted that while more than 100 Neolithic structures have been uncovered on archaeological excavations throughout Ireland, this is the first definitively identified example to have been discovered in the Belfast region (Smyth 2014; Ó Baoill 2011). Given that we have now established the presence of subsoil-cut features at the site, and given that these features evidently extend beyond the area investigated in Trench 2, the reconnaissance excavation must be judged as having been a success, with the potential that a larger-scale project might now be conducted at the site at a future date to further elucidate the nature of these prehistoric – and potentially early Neolithic – features.



Plate 7. Squire's Hill, Belfast, 28th April 2016. Backfilling the trenches, with Trench 1 to the left of the photo and Trench 2 to the right. Photo taken from south.

5. Acknowledgements

The excavation at Squire's Hill was commissioned Cultúrlann McAdam Ó Fiaich and the Spectrum Centre as part of the Farset Heritage Project, with funding provided by the Heritage Lottery Fund. We would particularly like to thank Aisling Ní Labhraí and Aoife Nic an tSaoir for all their help and advice during the course of the fieldwork. The illustrations included in this report were prepared by Sarah Gormley and Ruth Logue of the CAF, while Brian Sloan – also of the CAF – compiling the lithic report (see Appendix 1). The excavation would not have been possible without the consent of Richard George, on whose land the site is located, and we would like to thank him for all his assistance and forbearance during the course of the project. We would also like to thank Robert Heslip (Heritage Officer, Belfast City Council), Billy McGee, and Ken Pullin (Ulster Archaeological Society) for their interest in our work.

6. References

Evans, E.E. (1938): 'Notes on Excavations: Northern Ireland. Neolithic. Belfast, Co. Antrim', *Proceedings of the Prehistoric Society* 4 (1938), 322.

Nelis, E. (2003): *The Lithics of the Northern Irish Neolithic*. Unpublished PhD thesis, Queen's University Belfast.

Nelis, E. & Sloan B. (2004): *The Lithics from Ballyharry Farm, Islandmagee, Co. Antrim*, Unpublished specialist report prepared on behalf of the Centre for Archaeological Fieldwork, Queen's University Belfast.

Ó Baoill, R. (2011): *Hidden History Below Our Feet: The Archaeological Story of Belfast*, Tandem Design for the Northern Ireland Environment Agency and Belfast City Council.

Sloan, B. (2014): *The Lithics from excavations at Kilwaughter Quarry, Larne Co. Antrim*, Unpublished specialist report prepared on behalf of FarrimondMacMannus Ltd.

Smyth, J. (2014): *Settlement in the Irish Neolithic: new discoveries on the edge of Europe*, Prehistoric Society Research Paper 6. Oxbow Books & Prehistoric Society.

Appendix 1: Lithics Report.

Brian Sloan
Centre for Archaeological Fieldwork
Queen's University Belfast

Introduction

A total of 2206 lithics were recovered during the excavation of two trenches at Squires Hill, Belfast by the Centre for Archaeological Fieldwork, Queen's University Belfast. They were recovered from both topsoil deposits and from negative features that were excavated into the natural geological subsoil. This report details a visual inspection that was carried out on the lithics, although due to the nature of the assemblage it is not recommended that further statistical analysis be carried out. On the whole, the assemblage is characterised by thermally shattered lumps and chunks and indeterminate pieces (two small for positive identification). This is relatively common in locations that are rich in flint as a raw material, and also in areas that have undergone heavy agricultural use in the past. In general, the lithic assemblage recovered from Squire's Hill comprises: Cores (including fragments) - 0.2% (5 out of 2206 pieces); Complete flakes and blades – 3.7% (81 out of 2206 pieces); flake and blade shatter – 6.1% (135 out of 2206 pieces); modified tools – 0.7% (16 out of 2206 pieces) and Angular shatter – 89.3% (1969 out of 2206 pieces) (Figure 6).

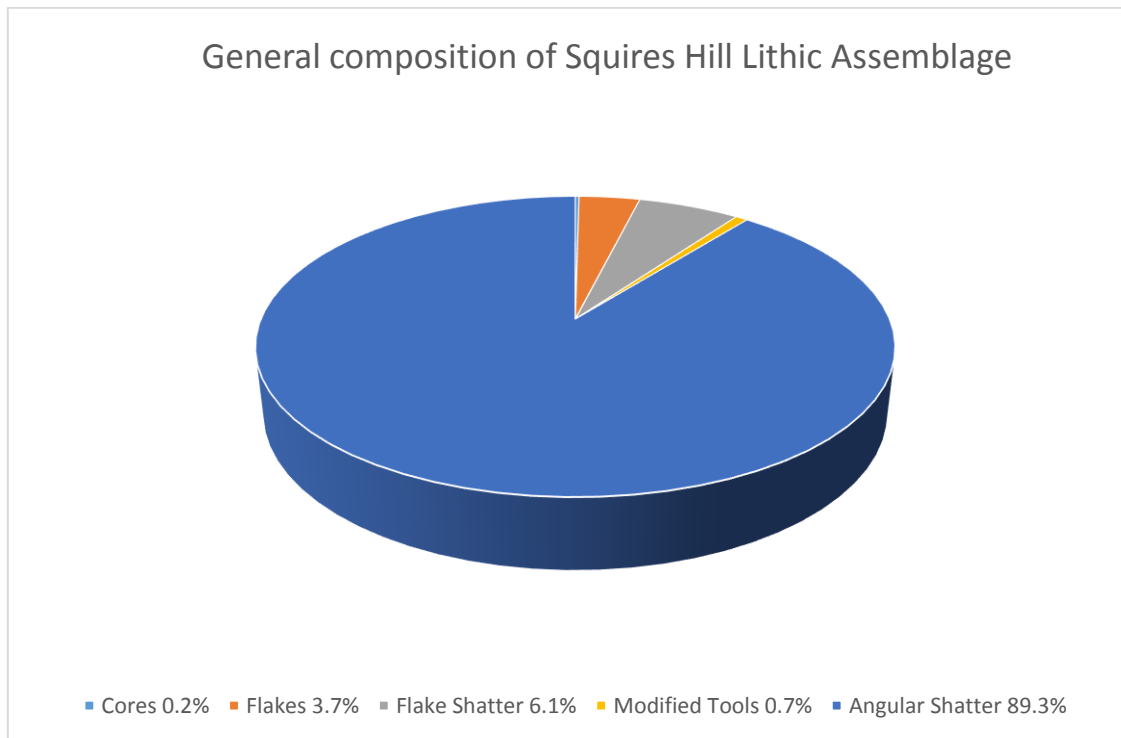

Figure 6. Squire's Hill, Belfast. General composition of the lithic assemblage.

Condition

The condition of the lithics varies throughout the assemblage. This is particularly apparent when comparing the lithics recovered from Trench One (exclusively recovered from topsoil C.102) to those recovered during the excavation of the negative features encountered in Trench Two. In general the lithics recovered during the excavation of the topsoil in both Trenches One and two exhibited varying degrees of post-depositional patina, abrasion and edge damage. This is common in places that have undergone substantial agricultural activity, where the flints are moved around the upper soil strata by ploughing.

The lithics recovered from the negative features in Trench Two were fresher than the rest of the assemblage (i.e. sharp edges and fresh, shiny, non-patinated appearance). This is to be expected due to their presence within a sub-soil cut feature affording them protection from being exposed and moved during ploughing. However, some of the pieces recovered from the negative features exhibited slight abrasion and patination, suggesting that they were in this state prior to becoming deposited in the features.

Angular Shatter

The vast majority of the lithic assemblage is comprised of elements of Angular Shatter accounting for 89.3% of the total (1969 out of 2206 pieces). This component includes thermally shattered chunks and lumps (of natural origin), but also those pieces that are too small to provide a positive identification. It is not deemed that this component of the assemblage is of archaeological significance and represents the background flint present on sites that are located close to natural sources of the raw material.

Primary Technology

Cores and core fragments made up 0.2% of the assemblage (5 out of 2206 pieces). On the whole they were relatively large multi-platform cores, which have become discarded prior to their full exploitation (in other words more flakes could have been detached prior to their deposition). This is quite common in flint rich areas where provision of the raw material was not an issue (Sloan 2014). Although relatively undiagnostic, multi-directional cores are common in assemblages dating to the Neolithic and Bronze Age.

The flake debitage component of the assemblage (complete and shattered flakes and blades) together account for 9.8% of the overall total (216 out of 2206 pieces). This component is dominated by unmodified planar platforms and feathered terminations indicating that the dominate reduction strategy utilised was direct percussion with a hard hammer stone. Little platform preparation was noted suggesting that the main intention was

the reduction of cores rather than the production of specific flake forms for tool production. However, the lack of cortical covering on the dorsal surfaces would suggest that the primary dressing of cores was carried out elsewhere.

Bi-polar knapping (the utilisation of an anvil stone) is evident on two flakes that form a refit (Small Find Number 6). These two flakes exhibit crushing on both the proximal and distal ends, and their presence in a stratified context indicates they were produced close to where they were recovered and at the very least that C211 was open when they were struck. Bi-polar reduction is traditionally viewed as a Bronze Age trait (although it does occur in Neolithic contexts – Nelis and Sloan 2004), although in this case, due to the lack of other bi-polar debitage from the site, it is probable that this dates to the Neolithic.

The presence of flakes exhibiting a ventral surface on both faces (double ventral flakes; SF#s 14, 15) is interesting and suggests the production of projectiles. The production of these flakes ensures a flat blank (lacking a dorsal surface and ridges) which could then be pressure flaked in the required shape and thickness. This technological process was identified in the Early Neolithic settlement at Thornhill Co. Derry (Nelis 2003) but could conceivably have been exploited into the Bronze Age.

Secondary Technology

A small number of modified tools was recovered during the excavation, accounting for 0.7% of the overall assemblage (16 out of 2206 pieces). A range of tool forms is represented in this component, with scrapers, simple hollow scrapers and retouched flakes present (Figure 2). In all cases, retouch is minimal and non-invasive suggesting that tools were produced in an ad hoc manner as and when needed rather than representing a concerted effort to produce formalised tool forms for repeated use.

A core axe roughout (Small Find Number 2) was recovered from the topsoil in Trench Two. This piece is relatively small in size and might have been intended as an adze or small axe. It is bi-facially worked exhibiting both percussion and pressure flaking on all surfaces. A large chunk has been removed from the cutting edge of the piece, although it is not clear if this occurred at the time of production or is post-depositional damage. Such items are common amongst Early Neolithic lithic assemblages (Nelis and Sloan 2004; Sloan 2014).

The presence of simple hollow scrapers indicate activity dating to the latter part of the Early Neolithic (prior to the development of complex hollow scrapers produced on a trapezoidal flake, a hollow or notch was produced on a regular flake). However, the rest of the modified tools are relatively undiagnostic and could have been produced at any point in prehistory.

Trench	Context	Small Find Number	Description
2	202	1	Large flake – prob. Early Neolithic
2	202	2	Axe roughout – Early Neolithic
2	202	3	Retouched flake
2	202	4	Retouched flake/possible scraper
2	204	5	Multi-directional core – Neolithic
2	210	6	Flint re-fit, Bi-polar – possibly Bronze Age
2	212	7	Scraper
2	212	8	Scraper
2	212	9	Multi-directional core – Neolithic
1	102	10	Fragment of Hollow Scraper – Early Neolithic
1	102	11	Fragment of Hollow Scraper – Early Neolithic
1	102	12	Scraper
1	102	13	Scraper
2	202	14	Double ventral flake – Early Neolithic
2	202	15	Double ventral flake – Early Neolithic
2	202	16	Retouched flake

Figure 7. Squire's Hill, Belfast. Lithics assigned Small Find Numbers.

Conclusions

The Squire's Hill lithic assemblage represents small scale prehistoric activity occurring at or close to the excavation site. Although relatively undiagnostic as a whole, certain elements within the assemblage point to an Early Neolithic date (the presence of simple hollow scrapers suggest a date in the later part of the Early Neolithic) for this activity.

Taking into account that only 10.7% of the assemblage is archaeological in nature, conclusions regarding the nature and date of the activity represented by the lithics must be regarded as tentative at best. It is apparent that the lack of formalised tools and the minimal nature of any retouch suggests that the knapping episodes were carried out in an ad hoc fashion producing basic tools as required. It is not clear whether this assemblage represents settlement, although the lack of prehistoric pottery might suggest that this area was used for industrial purposes and not as a domestic dwelling.

Appendix 2: Context Register

Context No.	Description	Interpretation
	Trench 1	
101	Sod layer.	Sod layer that constitutes the modern surface of the field. Above C.102. Same as C.201.
102	Mid-brown clay loam. Friable. Contained gravel and small stone inclusions.	Topsoil. Below C.101. Same as C.202.
103	Firm orange-brown sandy clay. Some small stone inclusions in areas and bedrock protruding throughout trench.	Subsoil. Below C.102. Same as C.203.
	Trench 2	
201	Mid-brown sandy clay loam. Contains many grass roots and occasional small angular stones.	Sod layer that constitutes the modern surface of the field. . Above C.202. Same as C.101.
202	Mid-brown sandy clay loam. Small angular stones.	Topsoil. Below C.201. Same as C.102.
203	Yellow-orange sandy clay.	Subsoil. Below C.202. Cut by C. 205 (fill C.204), C.207 (fill C.206), C.209 (fill C.208), C.211 (fill C.210), and C.213 (fill C.212).
204	Brown clay loam. Large angular stones.	Fill of modern cut C.205.
205	Cut in middle of trench. Modern, possibly machine-excavated.	Below C.202. Filled by C.204. Cuts linear cut C.211 and subsoil C.203.
206	Orange-brown sandy clay.	Fill of linear cut C.207.
207	Linear cut in south of trench. Prehistoric. Possibly structural.	Below C.202. Cuts subsoil C.203. Filled by C.206.
208	Dark brown sandy loam. Occasional charcoal flecking and small angular stones.	Below C. 202. Fill of pit/posthole C.209.
209	Cut in northern end of trench. Ran beyond limit of excavation. Prehistoric pit or post hole.	Below C.202. Filled by C. 208. Cuts subsoil C.203.
210	Mid-brown sandy loam.	Below C.202. Fill of linear cut C.211.

211	Linear cut in north of trench. Possibly structural. Contemporary with C. 213?	Below C.202. Filled by C.210. Cuts subsoil C.203. Cut by C.205.
212	Dark orange-brown sandy clay loam.	Below C.202. Fill of posthole C.213. Same as C210?
213	Cut. Possibly structural post hole. Contemporary with C. 211?	Below C.202. Filled by C.212.

Appendix 3: Harris Matrix

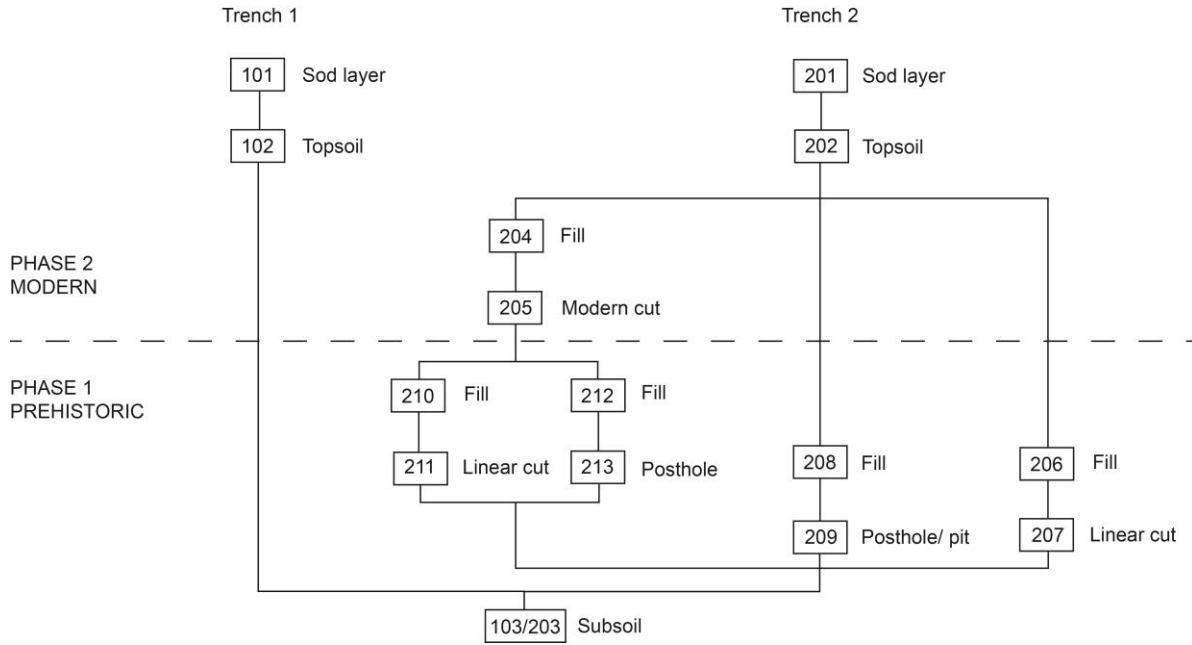

Appendix 4: Drawing register

Drawing No.	Type	Scale	Trench	Description	Date	Drawn by
1	Plan	1:20	2	Trench 2 following removal of C.202. Pre-excavation plan of trench.	21/4/2016	BS/ SG
2	Section	1:10	2	North-facing section of pit cut C.205	22/4/2016	SG
3	Section	1:10	2	South-facing section showing C.208 and C.209.	25/4/2016	BS
4	Section	1:10	2	North-west facing section through cut C.207.	25/4/2016	BS
5	Section	1:10	2	North-facing section.	25/4/2016	BS
6	Section	1:10	2	South-west facing section through cut C.211	25/4/2016	BS
7	Section	1:10	2	East-facing section through cut C.211.	25/4/2016	BS
8	Profile	1:10	2	North-south profile across cut C.205.	25/4/2016	BS
9	Section	1:10	2	West-facing section through cut C.213	25/4/2016	BS
10	Section	1:10	2	West-facing trench section.	25/4/2016	BS
11	Plan	1:20	2	Post excavation plan showing cuts C.205, C.207, C. 209, C.211 and C.213	25/4/2016	BS/ SG
12	Section	1:10	2 (extension)	North-facing section of Trench 2 extension.	28/4/2016	BS
13	Section	1:10	1	West-facing section of trench.	28/4/2016	GMcA/ RL
14	Section	1:10	1	North-facing section of trench.	28/4/2016	GMcA/ RL

Appendix 5: Photographic Register

Number	Date	Description
100_5518-5519	19/4/16	Trench 1, after de-sodding. From SW.
5520	19/4/16	Trench 2, during de-sodding. From SW.
5521	19/4/16	As 5518- 5519.
5522-5524	19/4/16	Trench 2 de-sodded, showing topsoil C.202. From S.
5525-5226	19/4/16	Trench 2 de-sodded, showing topsoil C.202. From N.
5527-5528	19/4/16	Trench 1 de-sodded, showing topsoil C.102. From S.
100_3561-3562	21/4/16	Trench 2, looking S after removal of C.202.
3563-3564	21/4/16	Trench 2, looking N after removal of C.202.
3565-3566	21/4/16	Trench 2, looking SW after removal of C.202.
3567	21/4/16	Trench 2, looking E after removal of C.202.
3568	21/4/16	As 3563-3564.
3569	21/4/16	As 3561-3562.
3570-3572	21/4/16	Women United group participating in the excavation. Robert Heslip, Belfast City Council also present.
3573	21/4/16	Trench 2 working shot. From S.
3574-	21/4/16	Trench 2. Working shot of cut C.211 (left of shot) and cut C.205 (right of shot) during excavation. From W.
3575-3576	21/4/16	Trench 2. Working shot of cut C.211 (foreground) and cut C.205 (background) during excavation. From N.
3577-3583	21/4/16	Trench 2 during excavation (foreground) and CAF photogrammetry workshop session in progress (background). From E.
3584-3585	21/4/16	Trenches 1 and 2 during excavation and CAF photogrammetry workshop session in progress. From N.
3586-3587	21/4/16	Trench 1 and CAF photogrammetry workshop session in progress. From N.
3588-3589	21/4/16	Trenches 1 and 2 during excavation and CAF photogrammetry workshop session in progress. From NW.
2590-3591	21/4/16	As 3588-3589. From NE.
3592-3599	22/4/16	Trench 1. Scoil Eanna, Belfast, participating in the excavation. From S, SW and W.
3600-3603	22/4/16	Trench 2. Pit cut C.205 and fill C.204 during excavation. From E, S, and N (2).
3604-3607	25/4/16	Jim Hazelwood School, Belfast, participating in the excavation.
3606-3611	25/4/16	Trench 2. Cut C.206, fill C.206 during excavation (Drawing No. 4). From NW.
3612-3613	26/4/16	Trench 2. Cut C.211, fill C.210 during excavation (Drawing No.7). From E.
3614-3615	26/4/16	Trench 2. Cuts C.211 (during excavation) and C.213 (post-excavation). From E.
3616-3617	26/4/16	Trench 2. Cut C.209, fill C.208 from S and SW.

Archaeological excavations at Squire's Hill, Belfast, Co. Antrim: AE/16/65

3618-3619	27/4/16	Trench 2, post-excavation. Showing cuts C.205, C.207, C.209, C.211 and C.213. From S.
3620-3621	27/4/16	Trench 2, post-excavation. Showing cuts C.205, C.207, C.209, C.211 and C.213. From N.
3622-3623	27/4/16	Trench 2, post-excavation. Showing cuts C.205, C.207, C.209, C.211 and C.213. From NW.
3624	27/4/16	Trench 2, post-excavation. Showing cuts C.205, C.207, C.209, C.211 and C.213. From W.
3625	27/4/16	Trench 2, post-excavation. Showing cuts C.205, C.207, C.209, C.211 and C.213. From SW.
3626	27/4/16	Trench 2, post-excavation. Showing cuts C.205, C.207, C.209, C.211 and C.213. From SE.
3627	27/4/16	Trench 2, post-excavation. Showing cuts C.205, C.207, C.209, C.211 and C.213. From E.
3628	27/4/16	Trench 2, post-excavation. Showing cuts C.205, C.207, C.209, C.211 and C.213. From NE.
3629-3632	27/4/16	Colaiste Feirste, Belfast, participating in the excavation.
3633	27/4/14	Trench 2. Extension at NE corner showing cut new section of C.211 pre-excavation. From N.
3634-3634	27/4/16	Trench 2. Extension at NE corner showing new section cut C.211 pre-excavation. From E.
3635-3638	28/4/16	Trench 2. New section of cut C.211 post-excavation. From N, E and N.
3639-3642	28/4/16	Trench 1, post-excavation. From N, S, N and S.
3643-3644	28/4/16	Trench 1, post-excavation. North-facing section.
3645	28/4/16	Trench 1, post-excavation. Northern half of west-facing section.
3646	28/4/16	Trench 1, post-excavation. Southern half of west-facing section.
3647-3649	29/4/16	Backfilled Trenches 1 and 2. From SW and S.
3650-3652	29/4/16	Backfilled Trench 1. From S.
3553-3654	29/4/16	Backfilled Trenches 1 and 2. From W.
3655	29/4/16	Backfilled Trench 1. From NW.
3656-3658	29/4/16	Backfilled Trench 1. From N, N and NE.
3659-3660	29/4/16	Backfilled Trench 1. From W and SE.
3661-3677	29/4/16	Backfilled Trench 2. From S, SW, W (2), N (3), NE (2) and E (5). Many shots taken to show the landscape in which the trenches were excavated

Appendix 6: Finds inventory

Special Finds

Special Finds Number	Context Number	Trench	Description
1	202 (topsoil)	2	Large flake. Probably Early Neolithic.
2	202 (topsoil)	2	Axe roughout. Early Neolithic.
3	202 (topsoil)	2	Re-touched flake.
4	202 (topsoil)	2	Re-touched flake. Possible scraper.
5	204 (fill of 205)	2	Multi-directional core. Neolithic.
6	210 (fill of 211)	2	Flint re-fit. Bi-polar knapping. Probably Bronze Age.
7	212 (fill of 213)	2	Scraper.
8	212 (fill of 213)	2	Scraper.
9	212 (fill of 213)	2	Multi-directional core. Neolithic.
10	102 (topsoil)	1	Fragment of hollow scraper. Early Neolithic.
11	102 (topsoil)	1	Fragment of hollow scraper. Early Neolithic.
12	102 (topsoil)	1	Scraper.
13	102 (topsoil)	1	Scraper.
14	202 (topsoil)	2	Double ventral flake. Early Neolithic.
15	202 (topsoil)	2	Double ventral flake. Early Neolithic.
16	202 (topsoil)	2	Re-touched flake
17	202 (topsoil)	2	Small blue glass bead. Bubbles in glass, perforation off-centre. Early Medieval

General Flint

Trench	Context Number	Description
1	102 (topsoil)	1213 pieces of flint. This comprises 1105 fragments of angular shatter, 2 core fragments, 40 complete flakes and 66 elements of flake shatter.
2	201 (sod)	16 pieces of flint. This comprises 9 fragments of angular shatter, 1 complete pressure flake and 6 elements of flake shatter.
2	202 (topsoil)	512 pieces of flint (including 3 special finds). This comprises 461 fragments of angular shatter, 17 complete flakes and 31 elements of flake shatter.
2	204 (fill of 205)	131 pieces of flint. This comprises 109 fragments of angular shatter, 1 multi-directional core, 9 complete flakes and 12 elements of flake shatter.
2	206 (fill of 207)	34 pieces of flint. This comprises 23 fragments of angular shatter, 4 complete flakes and 7 elements of flake shatter.
2	208 (fill of 209)	13 pieces of flint. This comprises 9 fragments of angular shatter and 4 elements of flake shatter.
2	210 (fill of 211)	209 pieces of flint. This comprises 195 fragments of angular shatter, 6 complete flakes, 7 elements of flake shatter and 1 minimally worked multi-directional core.
2	212 (fill of 213)	27 pieces of flint. This comprises 21 fragments of angular shatter, 4 undiagnostic flakes and 2 elements of flake shatter.

Ceramics

Trench	Context Number	Description
1	102 (topsoil)	1 ceramic bottle stopper.
1	102 (topsoil)	48 fragments of Post-Medieval pottery including Black Glazed Earthenware, Transfer Printed Ware, Creamware and Staffordshire ware.
2	202 (topsoil)	29 fragments of Post-Medieval pottery including Black Glazed Earthenware, Brown Glazed Earthenware, Creamware and Stoneware.
2	204 (fill of 205)	1 fragment of modern pottery.

Clay Tobacco Pipe

Trench	Context Number	Description
1	102 (topsoil)	1 fragment of bowl with partial stamp.
2	202 (topsoil)	1 undiagnostic fragment of bowl.

Lead

Trench	Context Number	Description
1	102 (topsoil)	1 piece of window leading.

Iron

Trench	Context Number	Description
2	204 (fill of 205)	1 corroded iron nail.

Slate

Trench	Context Number	Description
1	102 (topsoil)	1 fragment.
2	202 (topsoil)	1 fragment.

Glass

Trench	Context Number	Description
1	102 (topsoil)	9 fragments (7 of clear glass and 2 of green glass) of bottle and window glass.
2	201 (sod)	1 fragment of green bottle glass.
2	202 (topsoil)	1 fragment of clear bottle glass.